

PN2222A

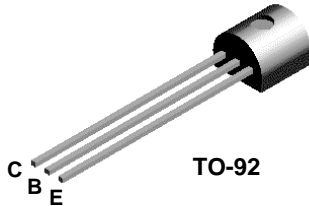

MMBT2222A

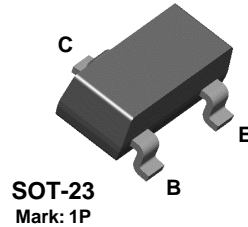

PZT2222A

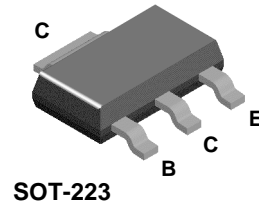

NPN General Purpose Amplifier

This device is for use as a medium power amplifier and switch requiring collector currents up to 500 mA. Sourced from Process 19.

Absolute Maximum Ratings* T_A = 25°C unless otherwise noted

| Symbol | Parameter | Value | Units |
|-----------------------------------|--|-------------|-------|
| V _{CEO} | Collector-Emitter Voltage | 40 | V |
| V _{CBO} | Collector-Base Voltage | 75 | V |
| V _{EBO} | Emitter-Base Voltage | 6.0 | V |
| I _C | Collector Current - Continuous | 1.0 | A |
| T _J , T _{stg} | Operating and Storage Junction Temperature Range | -55 to +150 | °C |

*These ratings are limiting values above which the serviceability of any semiconductor device may be impaired.

NOTES:

- 1) These ratings are based on a maximum junction temperature of 150 degrees C.
- 2) These are steady state limits. The factory should be consulted on applications involving pulsed or low duty cycle operations.

Thermal Characteristics T_A = 25°C unless otherwise noted

| Symbol | Characteristic | Max | | | Units |
|------------------|---|---------|------------|------------|-------|
| | | PN2222A | *MMBT2222A | **PZT2222A | |
| P _D | Total Device Dissipation | 625 | 350 | 1,000 | mW |
| | Derate above 25°C | 5.0 | 2.8 | 8.0 | mW/°C |
| R _{θJC} | Thermal Resistance, Junction to Case | 83.3 | | | °C/W |
| R _{θJA} | Thermal Resistance, Junction to Ambient | 200 | 357 | 125 | °C/W |

* Device mounted on FR-4 PCB 1.6" X 1.6" X 0.06."

** Device mounted on FR-4 PCB 36 mm X 18 mm X 1.5 mm; mounting pad for the collector lead min. 6 cm².

NPN General Purpose Amplifier

(continued)

Electrical Characteristics

$T_A = 25^\circ\text{C}$ unless otherwise noted

| Symbol | Parameter | Test Conditions | Min | Max | Units |
|----------------------------|--------------------------------------|---|-----|------------|--------------------------------|
| OFF CHARACTERISTICS | | | | | |
| $V_{(BR)CEO}$ | Collector-Emitter Breakdown Voltage* | $I_C = 10\text{ mA}, I_B = 0$ | 40 | | V |
| $V_{(BR)CBO}$ | Collector-Base Breakdown Voltage | $I_C = 10\ \mu\text{A}, I_E = 0$ | 75 | | V |
| $V_{(BR)EBO}$ | Emitter-Base Breakdown Voltage | $I_E = 10\ \mu\text{A}, I_C = 0$ | 6.0 | | V |
| I_{CEX} | Collector Cutoff Current | $V_{CE} = 60\text{ V}, V_{EB(OFF)} = 3.0\text{ V}$ | | 10 | nA |
| I_{CBO} | Collector Cutoff Current | $V_{CB} = 60\text{ V}, I_E = 0$ $V_{CB} = 60\text{ V}, I_E = 0, T_A = 150^\circ\text{C}$ | | 0.01 10 | μA μA |
| I_{EBO} | Emitter Cutoff Current | $V_{EB} = 3.0\text{ V}, I_C = 0$ | | 10 | nA |
| I_{BL} | Base Cutoff Current | $V_{CE} = 60\text{ V}, V_{EB(OFF)} = 3.0\text{ V}$ | | 20 | nA |

ON CHARACTERISTICS

| | | | | | |
|---------------|---------------------------------------|---|---|------------|--------|
| h_{FE} | DC Current Gain | $I_C = 0.1\text{ mA}, V_{CE} = 10\text{ V}$ $I_C = 1.0\text{ mA}, V_{CE} = 10\text{ V}$ $I_C = 10\text{ mA}, V_{CE} = 10\text{ V}$ $I_C = 10\text{ mA}, V_{CE} = 10\text{ V}, T_A = -55^\circ\text{C}$ $I_C = 150\text{ mA}, V_{CE} = 10\text{ V}^*$ $I_C = 150\text{ mA}, V_{CE} = 1.0\text{ V}^*$ $I_C = 500\text{ mA}, V_{CE} = 10\text{ V}^*$ | 35 50 75 35 100 50 40 | 300 | |
| $V_{CE(sat)}$ | Collector-Emitter Saturation Voltage* | $I_C = 150\text{ mA}, I_B = 15\text{ mA}$ $I_C = 500\text{ mA}, I_B = 50\text{ mA}$ | | 0.3 1.0 | V V |
| $V_{BE(sat)}$ | Base-Emitter Saturation Voltage* | $I_C = 150\text{ mA}, I_B = 15\text{ mA}$ $I_C = 500\text{ mA}, I_B = 50\text{ mA}$ | 0.6 | 1.2 2.0 | V V |

SMALL SIGNAL CHARACTERISTICS

| | | | | | |
|--------------|--|---|-----|-----|----------|
| f_T | Current Gain - Bandwidth Product | $I_C = 20\text{ mA}, V_{CE} = 20\text{ V}, f = 100\text{ MHz}$ | 300 | | MHz |
| C_{obo} | Output Capacitance | $V_{CB} = 10\text{ V}, I_E = 0, f = 100\text{ kHz}$ | | 8.0 | pF |
| C_{ibo} | Input Capacitance | $V_{EB} = 0.5\text{ V}, I_C = 0, f = 100\text{ kHz}$ | | 25 | pF |
| $rb'C_C$ | Collector Base Time Constant | $I_C = 20\text{ mA}, V_{CB} = 20\text{ V}, f = 31.8\text{ MHz}$ | | 150 | pS |
| NF | Noise Figure | $I_C = 100\ \mu\text{A}, V_{CE} = 10\text{ V},$ $R_S = 1.0\text{ k}\Omega, f = 1.0\text{ kHz}$ | | 4.0 | dB |
| $Re(h_{ie})$ | Real Part of Common-Emitter High Frequency Input Impedance | $I_C = 20\text{ mA}, V_{CE} = 20\text{ V},$ $f = 300\text{ MHz}$ | | 60 | Ω |

SWITCHING CHARACTERISTICS

| | | | | | |
|-------|--------------|---|--|-----|----|
| t_d | Delay Time | $V_{CC} = 30\text{ V}, V_{BE(OFF)} = 0.5\text{ V},$ $I_C = 150\text{ mA}, I_{B1} = 15\text{ mA}$ | | 10 | ns |
| t_r | Rise Time | | | 25 | ns |
| t_s | Storage Time | $V_{CC} = 30\text{ V}, I_C = 150\text{ mA},$ $I_{B1} = I_{B2} = 15\text{ mA}$ | | 225 | ns |
| t_f | Fall Time | | | 60 | ns |

*Pulse Test: Pulse Width $\leq 300\ \mu\text{s}$, Duty Cycle $\leq 2.0\%$

Spice Model

NPN (Is=14.34f Xti=3 Eg=1.11 Vaf=74.03 Bf=255.9 Ne=1.307 Ise=14.34f Ikf=.2847 Xtb=1.5 Br=6.092 Nc=2 Isc=0 Ikr=0 Rc=1 Cjc=7.306p Mjc=.3416 Vjc=.75 Fc=.5 Cje=22.01p Mje=.377 Vje=.75 Tr=46.91n Tf=411.1p Itf=.6 Vtf=1.7 Xtf=3 Rb=10)

PN2222A / MMBT2222A / PZT2222A

Typical Characteristics

Typical Pulsed Current Gain vs Collector Current

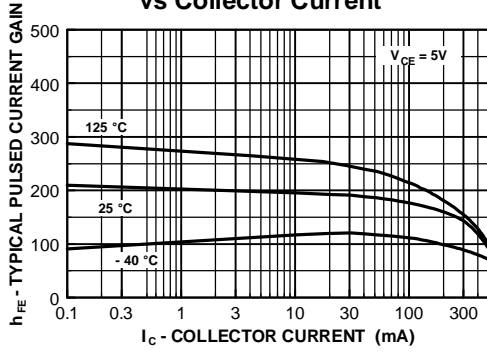

Collector-Emitter Saturation Voltage vs Collector Current

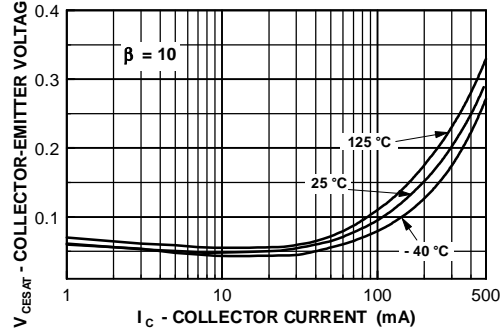

Base-Emitter Saturation Voltage vs Collector Current

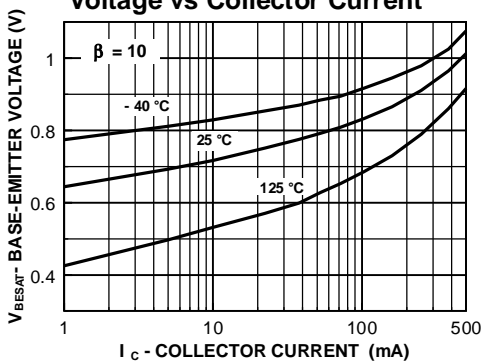

Base-Emitter ON Voltage vs Collector Current

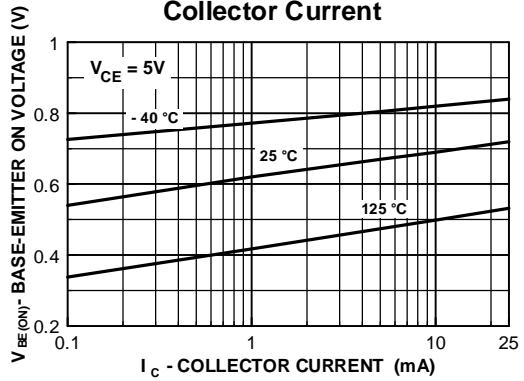

Collector-Cutoff Current vs Ambient Temperature

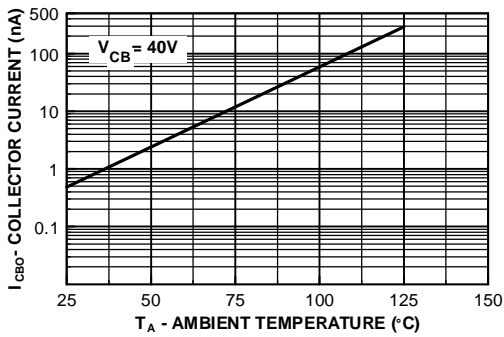

Emitter Transition and Output Capacitance vs Reverse Bias Voltage

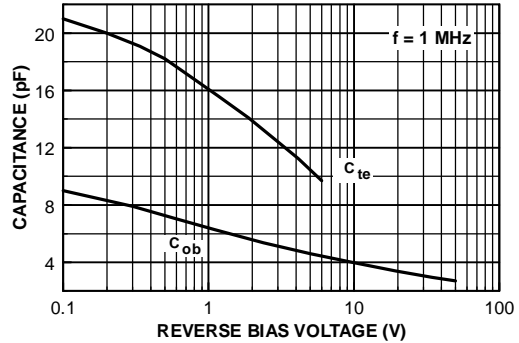

NPN General Purpose Amplifier

(continued)

PN2222A / MMBT2222A / PZT2222A

Typical Characteristics (continued)

Turn On and Turn Off Times vs Collector Current

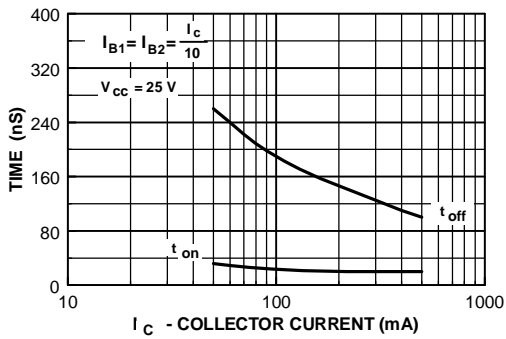

Switching Times vs Collector Current

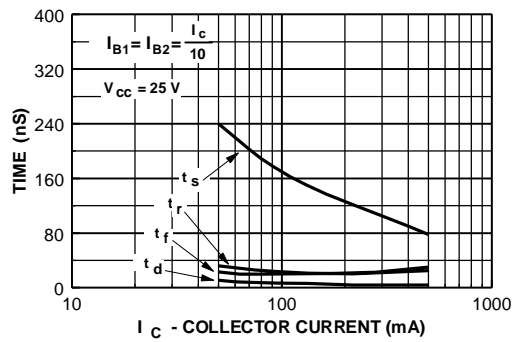

Power Dissipation vs Ambient Temperature

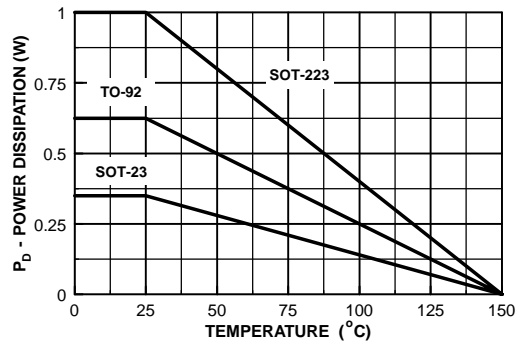

Typical Common Emitter Characteristics (f = 1.0kHz)

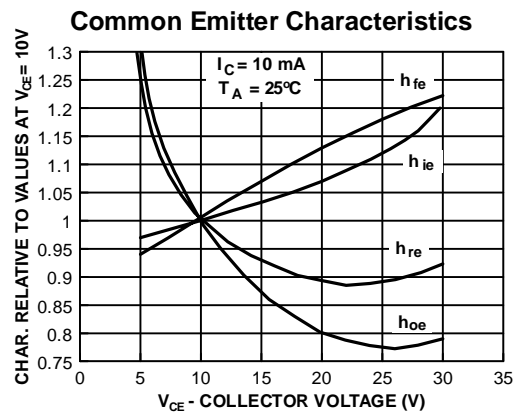
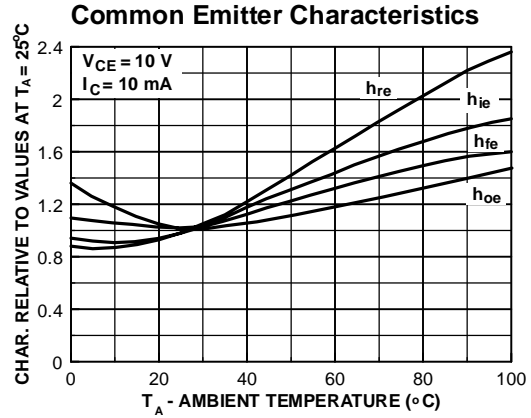
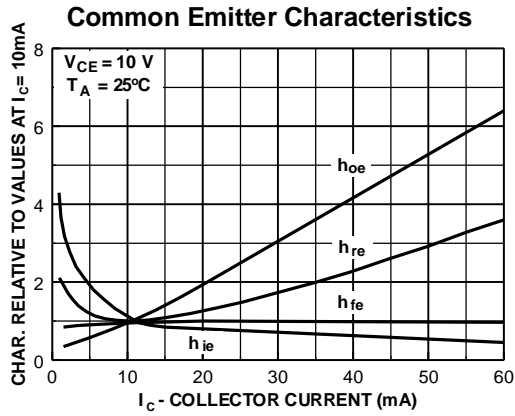

Test Circuits

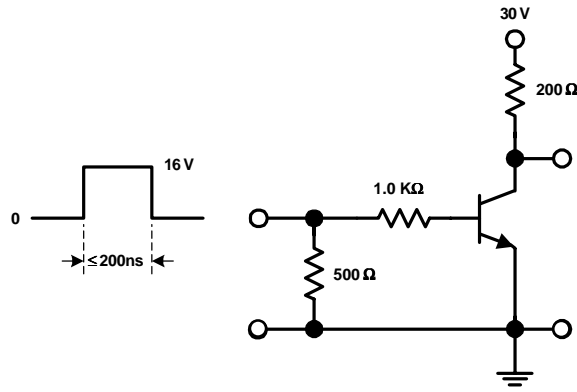

FIGURE 1: Saturated Turn-On Switching Time

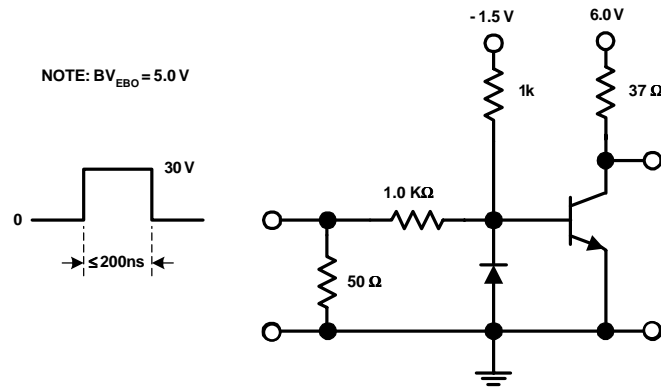

FIGURE 2: Saturated Turn-Off Switching Time

TRADEMARKS

The following are registered and unregistered trademarks Fairchild Semiconductor owns or is authorized to use and is not intended to be an exhaustive list of all such trademarks.

| | | | |
|-----------------------------------|-------------------------------------|----------------------------------|-------------------------|
| ACE ^x TM | FAST ^r TM | PowerTrench [®] | SyncFET TM |
| Bottomless TM | GlobalOptoisolator TM | QFET TM | TinyLogic TM |
| CoolFET TM | GTO TM | QS TM | UHC TM |
| CROSSVOLT TM | HiSeC TM | QT Optoelectronics TM | VCX TM |
| DO ^{ME} TM | ISOP ^{LANAR} TM | Quiet Series TM | |
| E ² CMOS TM | MICROWIRE TM | SILENT SWITCHER [®] | |
| EnSigna TM | OPTOLOGIC TM | SMART START TM | |
| FACT TM | OPTOPLANAR TM | SuperSOT TM -3 | |
| FACT Quiet Series TM | PACMAN TM | SuperSOT TM -6 | |
| FAST [®] | POP TM | SuperSOT TM -8 | |

DISCLAIMER

FAIRCHILD SEMICONDUCTOR RESERVES THE RIGHT TO MAKE CHANGES WITHOUT FURTHER NOTICE TO ANY PRODUCTS HEREIN TO IMPROVE RELIABILITY, FUNCTION OR DESIGN. FAIRCHILD DOES NOT ASSUME ANY LIABILITY ARISING OUT OF THE APPLICATION OR USE OF ANY PRODUCT OR CIRCUIT DESCRIBED HEREIN; NEITHER DOES IT CONVEY ANY LICENSE UNDER ITS PATENT RIGHTS, NOR THE RIGHTS OF OTHERS.

LIFE SUPPORT POLICY

FAIRCHILD'S PRODUCTS ARE NOT AUTHORIZED FOR USE AS CRITICAL COMPONENTS IN LIFE SUPPORT DEVICES OR SYSTEMS WITHOUT THE EXPRESS WRITTEN APPROVAL OF FAIRCHILD SEMICONDUCTOR CORPORATION. As used herein:

1. Life support devices or systems are devices or systems which, (a) are intended for surgical implant into the body, or (b) support or sustain life, or (c) whose failure to perform when properly used in accordance with instructions for use provided in the labeling, can be reasonably expected to result in significant injury to the user.
2. A critical component is any component of a life support device or system whose failure to perform can be reasonably expected to cause the failure of the life support device or system, or to affect its safety or effectiveness.

PRODUCT STATUS DEFINITIONS

Definition of Terms

| Datasheet Identification | Product Status | Definition |
|--------------------------|------------------------|---|
| Advance Information | Formative or In Design | This datasheet contains the design specifications for product development. Specifications may change in any manner without notice. |
| Preliminary | First Production | This datasheet contains preliminary data, and supplementary data will be published at a later date. Fairchild Semiconductor reserves the right to make changes at any time without notice in order to improve design. |
| No Identification Needed | Full Production | This datasheet contains final specifications. Fairchild Semiconductor reserves the right to make changes at any time without notice in order to improve design. |
| Obsolete | Not In Production | This datasheet contains specifications on a product that has been discontinued by Fairchild semiconductor. The datasheet is printed for reference information only. |